

Panasonic[®]

Basic Owner's Manual

Digital Camera/
Lens Kit

Model No. **DMC-GM1K**

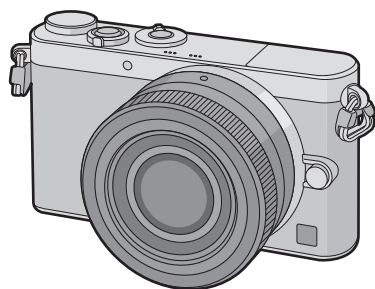

LUMIX

Please read these instructions carefully before using this product, and save this manual for future use.

More detailed instructions on the operation of this camera are contained in "Owner's Manual for advanced features (PDF format)" in the supplied CD-ROM. Install it on your PC to read it.



Register online at www.panasonic.com/register (U.S. customers only)

For USA and Puerto Rico assistance, please call: 1-800-211-PANA(7262) or, contact us via the web at: <http://www.panasonic.com/contactinfo>

(BC)

VQT5D49
F1013WT0

P

Confidential until
2013/10/31

-If you see this symbol-**Information on Disposal in other Countries outside the European Union**

This symbol is only valid in the European Union.

If you wish to discard this product, please contact your local authorities or dealer and ask for the correct method of disposal.

**Dear Customer,*****Thank you for choosing Panasonic!***

You have purchased one of the most sophisticated and reliable products on the market today. Used properly, we're sure it will bring you and your family years of enjoyment. Please take time to fill in the information below. The serial number is on the tag located on the underside of your camera. Be sure to **retain this manual** as your convenient camera information source.

Date of Purchase	Dealer Phone No.
Dealer Purchased From	Model No.
Dealer Address	Serial No.

Please note that the actual controls and components, menu items, etc. of your Digital Camera may look somewhat different from those shown in the illustrations in this Owner's Manual.

Carefully observe copyright laws.

- Recording of pre-recorded tapes or discs or other published or broadcast material for purposes other than your own private use may infringe copyright laws. Even for the purpose of private use, recording of certain material may be restricted.



A lithium ion battery that is recyclable powers the product you have purchased. Please call 1-800-8-BATTERY for information on how to recycle this battery.

Information for Your Safety**WARNING:**

To reduce the risk of fire, electric shock or product damage,

- Do not expose this unit to rain, moisture, dripping or splashing.
- Use only the recommended accessories.
- Do not remove covers.
- Do not repair this unit by yourself. Refer servicing to qualified service personnel.

The socket outlet shall be installed near the equipment and shall be easily accessible.

■ Product identification marking

Product	Location
Digital Camera	Bottom
Battery charger	Bottom

FCC Note:

This equipment has been tested and found to comply with the limits for a Class B digital device, pursuant to Part 15 of the FCC Rules. These limits are designed to provide reasonable protection against harmful interference in a residential installation. This equipment generates, uses, and can radiate radio frequency energy and, if not installed and used in accordance with the instructions, may cause harmful interference to radio communications. However, there is no guarantee that interference will not occur in a particular installation. If this equipment does cause harmful interference to radio or television reception, which can be determined by turning the equipment off and on, the user is encouraged to try to correct the interference by one or more of the following measures:

- Reorient or relocate the receiving antenna.
- Increase the separation between the equipment and receiver.
- Connect the equipment into an outlet on a circuit different from that to which the receiver is connected.
- Consult the dealer or an experienced radio/TV technician for help.

FCC Caution: To assure continued compliance, follow the attached installation instructions and use only shielded interface cables with ferrite core when connecting to computer or peripheral devices.

Any changes or modifications not expressly approved by the party responsible for compliance void the user's authority to operate this equipment.

Declaration of Conformity

Trade Name: Panasonic

Model No.: DMC-GM1

Responsible Party: Panasonic Corporation of North America

Two Riverfront Plaza, Newark, NJ 07102-5490

Support Contact Telephone No.: 1-800-211-PANA (7262)

This device complies with Part 15 of the FCC Rules. Operation is subject to the following two conditions: (1) This device may not cause harmful interference, and (2) this device must accept any interference received, including interference that may cause undesired operation.



Certification and Compliance

See Camera for the certification and compliance mark specific to that device.

- 1 Select [Wi-Fi] in the [Setup] menu.**
- 2 Select [Wi-Fi Setup] in the [Wi-Fi] menu.**
- 3 Press ▲/▼ to select [Approved Regulations], and then press [MENU/SET].**

Contains FCC ID: VPYLBXN604

This transmitter must not be co-located or operated in conjunction with any other antenna or transmitter.

This equipment complies with FCC radiation exposure limits set forth for an uncontrolled environment and meets the FCC radio frequency (RF) Exposure Guidelines in Supplement C to OET65.
This equipment has very low levels of RF energy that are deemed to comply without testing of specific absorption ratio (SAR).

■ About the battery pack

CAUTION

Battery pack (Lithium ion battery pack)

- Use the specified unit to recharge the battery pack.
- Do not use the battery pack with equipment other than the specified unit.
- Do not get dirt, sand, liquids, or other foreign matter on the terminals.
- Do not touch the plug terminals (+ and -) with metal objects.
- Do not disassemble, remodel, heat or throw into fire.

If any electrolyte should come into contact with your hands or clothes, wash it off thoroughly with water.

If any electrolyte should come into contact with your eyes, never rub the eyes. Rinse eyes thoroughly with water, and then consult a doctor.

CAUTION

- Danger of explosion if battery is incorrectly replaced. Replace only with the type recommended by the manufacturer.
- When disposing of the batteries, please contact your local authorities or dealer and ask for the correct method of disposal.

- Do not heat or expose to flame.
- Do not leave the battery(ies) in a car exposed to direct sunlight for a long period of time with doors and windows closed.

Warning

Risk of fire, explosion and burns. Do not disassemble, heat above 60 °C (140 °F) or incinerate.

4 VQT5D49 (ENG)

■ About the battery charger

CAUTION!

**To reduce the risk of fire, electric shock or product damage,
• Do not install or place this unit in a bookcase, built-in cabinet or in another confined space. Ensure this unit is well ventilated.**

Battery charger

This battery charger operates on AC between 110 V and 240 V.

But

- In the U.S.A. and Canada, the battery charger must be connected to a 120 V AC power supply only.
- When connecting to an AC supply outside of the U.S.A. or Canada, use a plug adaptor to suit the AC outlet configuration.

Cautions for Use

- Do not use any other USB connection cables except the supplied one or a genuine Panasonic USB connection cable (DMW-USBC1: optional).
- Use a "High Speed HDMI micro cable" with the HDMI logo.
Cables that do not comply with the HDMI standards will not work.
"High Speed HDMI micro cable" (Type D—Type A plug, up to 2 m (6.6 feet) long)
- Always use a genuine Panasonic AV cable (DMW-AVC1: optional).

Keep this unit as far away as possible from electromagnetic equipment (such as microwave ovens, TVs, video games etc.).

- If you use this unit on top of or near a TV, the pictures and/or sound on this unit may be disrupted by electromagnetic wave radiation.
- Do not use this unit near cell phones because doing so may result in noise adversely affecting the pictures and/or sound.
- Recorded data may be damaged, or pictures may be distorted, by strong magnetic fields created by speakers or large motors.
- Electromagnetic wave radiation may adversely affect this unit, disturbing the pictures and/or sound.
- If this unit is adversely affected by electromagnetic equipment and stops functioning properly, turn this unit off and remove the battery or disconnect AC adaptor (DMW-AC8PP: optional). Then reinsert the battery or reconnect AC adaptor and turn this unit on.

Do not use this unit near radio transmitters or high-voltage lines.

- If you record near radio transmitters or high-voltage lines, the recorded pictures and/or sound may be adversely affected.
- **Before cleaning the camera, remove the battery or the DC coupler (DMW-DCC15: optional), or disconnect the power plug from the outlet.**
- **Do not press the monitor with excessive force.**
- **Do not press the lens with excessive force.**
- **Do not use solvents such as benzine, thinner, alcohol, kitchen detergents, etc., to clean the camera, since it may deteriorate the external case or the coating may peel off.**
- **Do not leave the camera with the lens facing the sun as rays of light from the sun may cause it to malfunction.**

Contents

Information for Your Safety	2
• Cautions for Use	5

Preparation

Reading the Owner's Manual (PDF format)	7
Care of the camera	8
Standard Accessories	9
Names and Functions of Components	11
Preparation	14
• Changing the Lens	14
• Attaching the Shoulder Strap	14
• Charging the Battery	15
• Inserting/Removing the Battery.....	16
• Inserting/Removing the Card (Optional)	16
• Formatting the card (initialization).....	17
• Setting Date/Time (Clock Set).....	17
Setting the Menu	18
• Setting menu items	18
Calling frequently-used menus instantly (Quick Menu)	19
Assigning frequently used functions to the buttons (function buttons).....	19

Basic

Taking a Still picture	20
Recording Motion Picture	20
Selecting the Recording Mode	21
Playing Back Pictures/ Motion Pictures	22
• Playing Back Pictures	22
• Playing Back Motion Pictures.....	22
Deleting Pictures	23

Recording

Taking Pictures using the Automatic Function (Intelligent Auto Mode)	24
Taking Pictures with Manual Focus	26

Wi-Fi

Controlling with a Smartphone/ Tablet	27
• Installing the smartphone/ tablet app "Image App"	27
• Connecting to a smartphone/ tablet	28
• Taking pictures via a smartphone/ tablet (remote recording).....	28
• Saving images stored in the camera/ Sending images in the camera to an SNS	28

About the supplied software

About the supplied software	29
--	----

Others

Monitor Display	30
Menu list	35
• [Rec]	35
• [Motion Picture].....	36
• [Custom]	37
• [Setup]	38
• [Playback]	39
Troubleshooting	40
Specifications	44
Digital Camera Accessory System ...	50
Digital Camera Accessory Order Form(For USA and Puerto Rico Customers)	51
Limited Warranty (ONLY FOR U.S.A. AND PUERTO RICO)	52

Reading the Owner's Manual (PDF format)

More detailed instructions on the operation of this camera are contained in "Owner's Manual for advanced features (PDF format)" in the supplied CD-ROM. Install it on your PC to read it.

■ For Windows

- 1 Turn the PC on and insert the CD-ROM containing the Owner's Manual (supplied).
- 2 Select the desired language and then click **[Owner's Manual]** on the install menu to install.
 - If the automatic playback screen is displayed, you can display the menu by selecting and executing [Manual.exe].
 - In Windows 8, you can display the menu by clicking a message that is displayed after inserting the CD-ROM and then selecting and executing [Manual.exe].
 - You can also display the menu by double-clicking [VFFXXXX] in [Computer] (XXXX differs depending on the model).
- 3 Double click the "Owner's Manual" shortcut icon on the desktop.

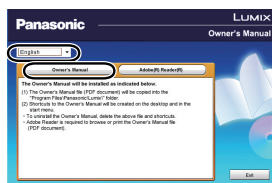

■ When the Owner's Manual (PDF format) will not open

You will need Adobe Acrobat Reader 5.0 or later or Adobe Reader 7.0 or later to browse or print the Owner's Manual (PDF format).

- You can download and install a version of Adobe Reader that you can use with your OS from the following Web Site.

<http://get.adobe.com/reader/otherversions>

■ To uninstall the Owner's Manual (PDF format)

Delete the PDF file from the "Program Files\Panasonic\Lumix" folder.

■ For Mac

- 1 Turn the PC on and insert the CD-ROM containing the Owner's Manual (supplied).
- 2 Open the "Manual" folder in the CD-ROM and then copy the PDF file with the desired language inside the folder.
- 3 Double click the PDF file to open it.

Preparation

Care of the camera

Do not subject to strong vibration, shock, or pressure.

- The lens, monitor, or external case may be damaged if used in the following conditions. It may also malfunction or image may not be recorded if you:
 - Drop or hit the camera.
 - Press hard on the lens or the monitor.

This camera is not dust/drip/water proof.

Avoid using the camera in places with a lot of dust, water, sand, etc.

- Liquid, sand and other foreign material may get into the space around the lens, buttons, etc. Be particularly careful since it may not just cause malfunctions, but it may also become irreparable.
 - Places with a lot of sand or dust.
 - Places where water can come into contact with this unit, such as when using it on a rainy day or at the beach.

Do not place your hands inside the mount of the digital camera body. Since the sensor unit is a precision apparatus, it may cause a malfunction or damage.

■ About Condensation (When the lens or monitor is fogged up)

- Condensation occurs when the ambient temperature or humidity changes. Be careful of condensation since it causes lens and monitor stains, fungus and camera malfunction.
- If condensation occurs, turn the camera off and leave it for about 2 hours. The fog will disappear naturally when the temperature of the camera becomes close to the ambient temperature.

Standard Accessories

Check that all the accessories are supplied before using the camera.
Product numbers correct as of October 2013. These may be subject to change.

Digital Camera Body
(This is referred to as **camera body** in this owner's manual.)

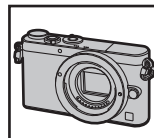

(○: Included, —: Not included)

		DMC-GM1K
1	Interchangeable Lens*1	○*3
2	Lens Cap	○*2

- 3 Battery Pack
(Indicated as **battery pack** or **battery** in the text)
Charge the battery before use.
- 4 Battery Charger
(Indicated as **battery charger** or **charger** in the text)
- 5 USB Connection Cable
- 6 CD-ROM
- Software:
Use it to install the software to your PC.
- 7 CD-ROM
- Owner's Manual for advanced features:
Use it to install to your PC.
- 8 Shoulder Strap



*1 This is referred to as **lens** in this owner's manual.





*2 This is attached to the interchangeable lens at the time of purchase.

*3 This is attached to the camera body at the time of purchase.

- SD Memory Card, SDHC Memory Card and SDXC Memory Card are indicated as **card** in the text.
- **The card is optional.**
- Description in this owner's manual is based on the interchangeable lens (H-FS12032).
- **Do not leave any metal items (such as clips) near the contact areas of the power plug or near the batteries.**
- Store the battery in a cool and dry place with a relatively stable temperature: (Recommended temperature: 15 °C to 25 °C (59 °F to 77 °F), Recommended humidity: 40%RH to 60%RH)
- **Do not store the battery for a long time while fully charged.**
- When storing the battery for a long period of time, we recommend charging it once a year. Remove the battery from the camera and store it again after it has completely discharged.
- If any accessories are lost, customers should contact Panasonic's parts department at 1-800-833-9626 for further information about obtaining replacement parts.

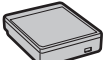
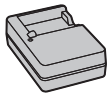
Preparation

DMC-GM1K	
1	 H-FS12032
2	 VYF3562

3  DMW-BLH7PP	4  DE-A99B	5  K1HY08YY0031	6 
7  VFF1243	8  VFC5071		

Names and Functions of Components

■ Camera body

- 1 Self-timer indicator/
AF Assist Lamp
- 2 Sensor
- 3 Flash
- 4 Lens fitting mark (P14)
- 5 Mount
- 6 Lens lock pin
- 7 Lens release button (P14)

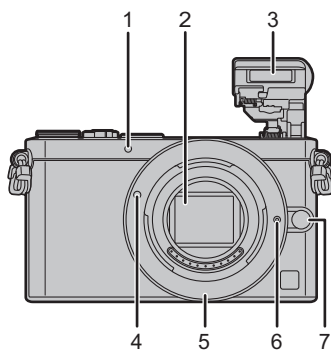

- 8 Flash open lever
 - The flash opens, and recording with the flash becomes possible.
- 9 Speaker
 - Be careful not to cover the speaker with your finger. Doing so may make sound difficult to hear.
- 10 Motion picture button (P20)
- 11 [▶] (Playback) button (P22)
- 12 Touch screen/monitor (P13)
- 13 [MENU/SET] button (P18)
- 14 [⏏] (Delete) button (P23)/
[Q.MENU/↵] (Quick Menu/Return) button (P19)
- 15 Control dial
- 16 [DISP.] button
 - Each time this is pressed, the display on the monitor is switched.
- 17 Cursor buttons
 - ▲/[⏏] (Exposure Compensation)
 - ▶/[WB] (White Balance)
 - ◀/[AF] (Auto Focus Mode)
 - ▼/[⏏] (Drive mode)
Single/Burst/Auto bracket/Self-timer

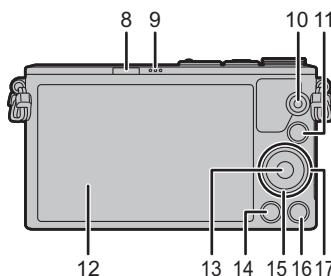

Preparation

18 Stereo microphone

- Be careful not to cover the microphone with your finger. Doing so may make sound difficult to record.

19 Camera ON/OFF switch (P17)**20 Shutter button (P20)****21 Focus distance reference mark****22 [Fn1] button (P19)**

- At the time of purchase, [Wi-Fi] is set to [Fn1]. (P27)

23 Focus mode lever (P26)**24 Status indicator (P17)/**

Wi-Fi® connection lamp

- The lamp lights green when the camera is turned on, and lights blue when it is connected to Wi-Fi.

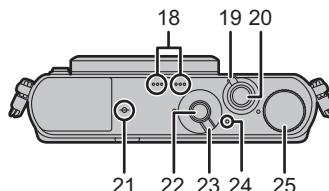
25 Mode dial (P21)**26 Shoulder strap eyelet (P14)**

- Be sure to attach the shoulder strap when using the camera to ensure that you will not drop it.

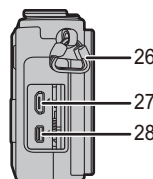
27 [HDMI] socket**28 [AV OUT/DIGITAL] socket****29 Tripod mount**

- A tripod with a screw length of 5.5 mm (0.22 inch) or more may damage this unit if attached.

30 Card/Battery door (P16)**31 DC coupler cover**

- When using an AC adaptor, ensure that the Panasonic DC coupler (DMW-DCC15: optional) and AC adaptor (DMW-AC8PP: optional) are used.
- Always use a genuine Panasonic AC adaptor (DMW-AC8PP: optional).
- It is recommended to use a fully charged battery or AC adaptor when recording motion pictures.
- If while recording motion pictures using the AC adaptor and the power supply is cut off due to a power outage or if the AC adaptor is disconnected etc., the motion picture will not be recorded.

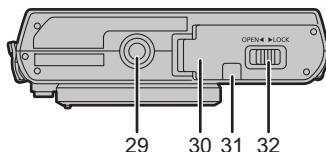
32 Release lever (P16)

■ Lens

H-FS12032

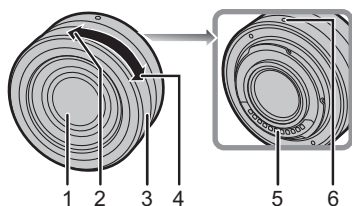

- 1 Lens surface
- 2 Tele
- 3 Zoom ring
- 4 Wide
- 5 Contact point
- 6 Lens fitting mark

• The interchangeable lens (H-FS12032) does not have a focus ring, but you can use manual focus by operating the camera. Refer to P26 for details.

■ Touch screen (capacitive)

Operate the touch screen directly with your finger.

■ Touch

To touch and release the touch screen.

- When selecting features using the touch screen, be sure to touch the center of the desired icon.

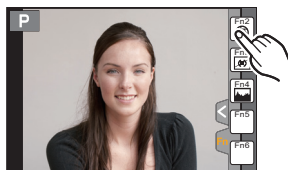

■ Drag

A movement without releasing the touch screen.

This can also be used to move to the next image during playback, etc.

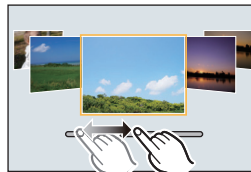

■ Pinch (enlarge/reduce)

Pinch the touch panel apart (enlarge) or together (reduce) with two fingers.

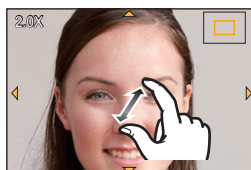

Preparation

Preparation

- Check that the camera is turned off.

Changing the Lens

- When attaching or detaching the interchangeable lens (H-FS12032), retract the lens barrel.
- Change lenses where there is not a lot of dirt or dust.

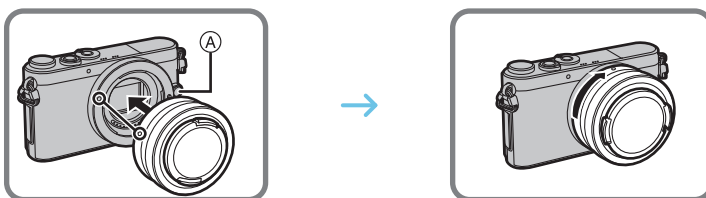

- Do not press the lens release button (A) when you attach a lens.

■ Detaching the lens

- 1 Attach the lens cap.
- 2 While pressing on the lens release button (A), rotate the lens toward the arrow until it stops and then remove.

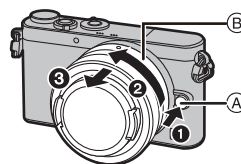

- Hold and rotate the base area of the lens (B).

Attaching the Shoulder Strap

- We recommend attaching the shoulder strap when using the camera to prevent it from dropping.

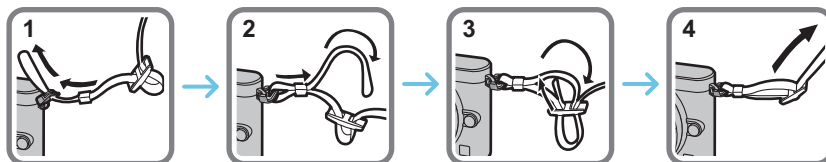

- Perform steps 1 to 4 and then attach the other side of the shoulder strap.

- Use the shoulder strap around your shoulder.
 - Do not wrap the strap around your neck.
 - It may result in injury or accident.
- Do not leave the shoulder strap where an infant can reach it.
 - It may result in an accident by mistakenly wrapping around the neck.

Charging the Battery

The battery that can be used with this unit is DMW-BLH7PP.

• The battery is not charged when the camera is shipped. Charge the battery before use.

- 1 Attach the battery paying attention to the direction of the battery.
- 2 Connect the charger to the electrical outlet.

• The [CHARGE] indicator (A) lights up and charging begins.

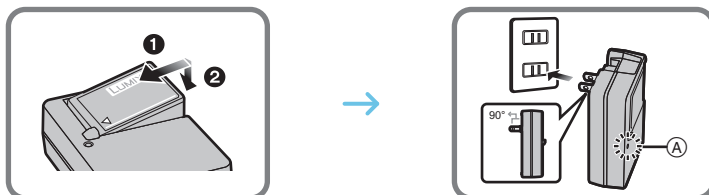

■ About the [CHARGE] indicator

On: Charging.

Off: Charging has completed.

(Disconnect the charger from the electrical socket and detach the battery after charging is completed.)

• When the [CHARGE] indicator flashes

- The battery temperature is too high or too low. It is recommended to charge the battery again in an ambient temperature of between 10 °C and 30 °C (50 °F and 86 °F).
- The terminals of the charger or the battery are dirty. In this case, wipe them with a dry cloth.

■ Charging time

Charging time

Approx. 130 min

• The indicated charging time is for when the battery has been discharged completely.

The charging time may vary depending on how the battery has been used.

The charging time for the battery in hot/cold environments or a battery that has not been used for a long time may be longer than normal.

Preparation

Inserting/Removing the Battery

- Always use genuine Panasonic batteries (DMW-BLH7PP).
- If you use other batteries, we cannot guarantee the quality of this product.

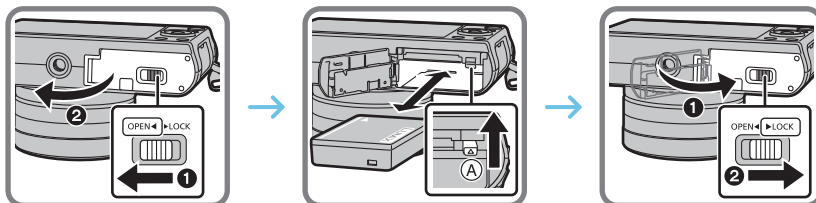

- Being careful about the battery orientation, insert all the way until you hear a locking sound and then check that it is locked by lever A.
- Pull the lever A in the direction of the arrow to remove the battery.

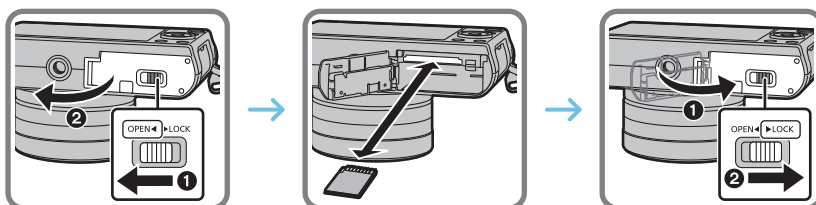
Inserting/Removing the Card (Optional)

- Push it securely all the way until you hear a "click" while being careful about the direction in which you insert it.

■ **About cards that can be used with this unit**

SD Memory Card (8 MB to 2 GB)
 SDHC Memory Card (4 GB to 32 GB)
 SDXC Memory Card (48 GB, 64 GB)

■ **About the motion picture recording and SD speed class**

Confirm the SD Speed Class (the speed standard regarding continuous writing) on a card label etc. when you record a motion picture. Use a card with SD Speed Class with "Class 4" or more for [AVCHD]/[MP4] motion picture recording.

e.g.:

CLASS **4** **4**

- Please confirm the latest information on the following website.

<http://panasonic.jp/support/global/cs/dsc/>

(This Site is English only.)

- Keep the Memory Card out of reach of children to prevent swallowing.

Formatting the card (initialization)

Format the card before recording a picture with this unit.

Since data cannot be recovered after formatting, make sure to back up necessary data in advance.

Select the menu. (P18)

MENU →  **[Setup]** → **[Format]**

• Confirmation screen is displayed. It is executed when [Yes] is selected.

Setting Date/Time (Clock Set)

• The clock is not set when the camera is shipped.

1 Turn the camera on.

• When the camera is turned on, the status indicator **1** lights up green.

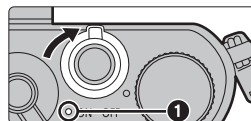

2 Press [MENU/SET].

3 Press ◀/▶ to select the items (year, month, day, hour, minute), and press ▲/▼ to set.

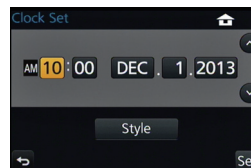

4 Press [MENU/SET] to set.

5 Press [MENU/SET] in the confirmation screen.

• When an interchangeable lens (H-FS12032) is used and the lens barrel is retracted, recording is not possible (a message will be displayed). Rotate the zoom ring to extend the lens.

Preparation

Setting the Menu

Setting menu items

- 1 Press [MENU/SET].
- 2 Press ▲/▼ of the cursor button to select the menu item and press [MENU/SET].
- 3 Press ▲/▼ of the cursor button to select the setting and press [MENU/SET].
 - Depending on the menu item, its setting may not appear or it may be displayed in a different way.

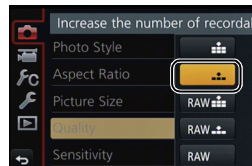
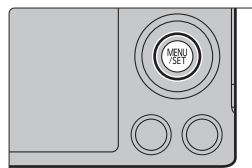

■ **Close the menu**
Press [Q.MENU/↵] or press the shutter button halfway.

- **Switching to other menus**
e.g.: Switching to the [Setup] menu from [Rec] menu.
- 1 Press ◀.
 - 2 Press ▲/▼ to select [⚙] or another of the menu toggle icons (A).
 - 3 Press [MENU/SET].

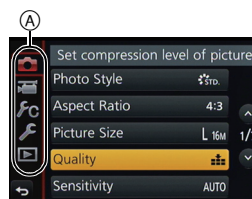

Preparation

Calling frequently-used menus instantly (Quick Menu)

By using the Quick Menu, some of the menu settings can be easily found.

- The features that can be adjusted using Quick Menu are determined by the mode or a display style the camera is in.

1 Press [Q.MENU/↵] to display the Quick Menu.

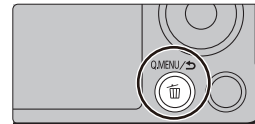

2 Rotate the control dial to select the menu item, and press ▼ or ▲.

- The menu item can also be selected by pressing ◀▶.

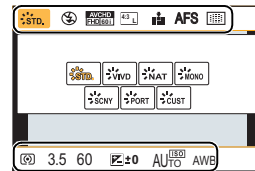

3 Rotate the control dial to select the setting.

- The setting can also be selected with ◀▶.

4 Press [Q.MENU/↵] to exit the menu once the setting is complete.

- You can close the menu by pressing the shutter button halfway.

Assigning frequently used functions to the buttons (function buttons)

You can assign recording functions, etc. to specific buttons and icons.

1 Select the menu.

MENU → **fC [Custom]** → **[Fn Button Set]**

2 Press ▲/▼ to select the function button you want to assign a function to and then press [MENU/SET].

3 Press ▲/▼ to select the function you want to assign and then press [MENU/SET].

- Some functions cannot be assigned depending on the function button.

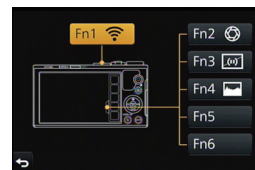

Basic

Taking a Still picture

- When the interchangeable lens (H-FS12032) is attached, extend the lens barrel before use.
- Set the drive mode to [] (single) by pressing ▼().

- 1 Select the Recording Mode. (P21)**
- 2 Press the shutter button halfway to focus.**

- (A) Aperture value
- (B) Shutter speed

- Aperture value and shutter speed are displayed. (It will flash in red if the correct exposure is not achieved, except when set to flash.)
- **When the image is correctly focused, the picture will be taken, since the [Focus/Release Priority] is set initially to [FOCUS].**

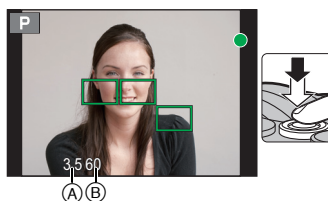

- 3 Press the shutter button fully (push it in further), and take the picture.**



Recording Motion Picture

This camera can record full high definition motion pictures compatible with the AVCHD format or motion pictures recorded in MP4. Audio will be recorded in stereo.

- 1 Start recording by pressing the motion picture button.**

- (A) Elapsed recording time
- (B) Available recording time
- Recording of motion picture appropriate for each mode is possible.
- If approximately 1 minute elapses without an operation being performed, part of the display will disappear. Press [DISP.] or touch the monitor to make the display reappear.
- Release the motion picture button right after you press it.

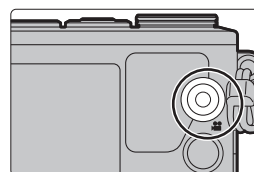

- 2 Stop the recording by pressing the motion picture button again.**

- Maximum time to record motion pictures continuously with [MP4] is 29 minutes 59 seconds or up to 4 GB. (For [FHD/30p] in [MP4] format, the file size is large and so the recordable time will drop below 29 minutes 59 seconds.)
- When a high ambient temperature, continuous motion picture recording or other conditions are causing the camera to overheat, [] flashes. If a message is displayed after [] flashes, the camera will turn off automatically to protect itself. When this happens, some functions will be disabled until the camera cools down.
- Still picture recording is also possible during the motion picture recording by fully pressing the shutter button.

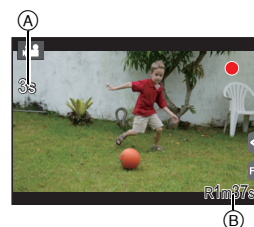

Selecting the Recording Mode

Select the mode by rotating the mode dial.

- Rotate the mode dial slowly to select the desired mode.

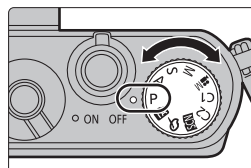

iA Intelligent Auto Mode

The subjects are recorded using settings automatically selected by the camera.

iA+ Intelligent Auto Plus Mode

Allows you to adjust the brightness and color hue when in Intelligent Auto Mode.

P Program AE Mode

Records at the aperture value and shutter speed set by the camera.

A Aperture-Priority AE Mode

The shutter speed is automatically determined by the aperture value you set.

S Shutter-Priority AE Mode

The aperture value is automatically determined by the shutter speed you set.

M Manual Exposure Mode

The exposure is adjusted by the aperture value and the shutter speed which are manually adjusted.

M Creative Video Mode

Records motion pictures with a manually set aperture value and shutter speed.

* You cannot take still pictures.

C1 C2 Custom Mode

Use this mode to take pictures with previously registered settings.

SCN Scene Guide Mode

This mode allows you to take pictures that match the scene being recorded.

Creative Control Mode

Record while checking the image effect.

Basic

Playing Back Pictures/Motion Pictures

Playing Back Pictures

1 Press [▶].

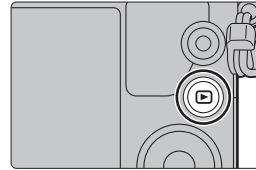

2 Press ◀▶.

- ◀: Play back the previous picture
- ▶: Play back the next picture



Playing Back Motion Pictures

This unit was designed to play motion pictures using the AVCHD, MP4 and QuickTime Motion JPEG formats.

- Motion pictures are displayed with the motion picture icon ([▶]).

Press ▲ to play back.

(A) Motion picture recording time

- After playback starts, the elapsed playback time is displayed on the screen.



■ Operations during Motion Picture Playback

▲	▶/	Play/Pause	▼	■	Stop
◀	◀◀	Fast rewind	▶	▶▶	Fast forward
	◀	Frame-by-frame rewind (while pausing)		▶	Frame-by-frame forward (while pausing)
([▶])	-	Reduce volume level	([▶])	+	Increase volume level

Deleting Pictures

Once deleted, pictures cannot be recovered.

To delete a single picture

- 1 In Playback Mode, select the picture to delete and then press [RECALL].**

- The same operation can be performed by touching [RECALL].

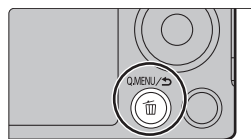

- 2 Press ▲ to select [Delete Single] and then press [MENU/SET].**

- Confirmation screen is displayed.
Picture is deleted by selecting [Yes].

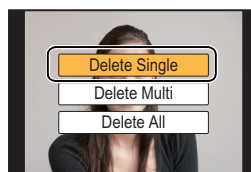

To delete multiple pictures (up to 100*) or all the pictures

* Picture groups are treated as a single picture.
(All the pictures in the selected picture group will be deleted.)

- 1 In Playback Mode, press [RECALL].**
- 2 Press ▲/▼ to select [Delete Multi] or [Delete All] and then press [MENU/SET].**

- [Delete All] → Confirmation screen is displayed.
Pictures are deleted by selecting [Yes].
- It is possible to delete all pictures except the ones set as favorite when [All Delete Except Favorite] is selected with the [Delete All] set.

- 3 (When [Delete Multi] is selected)
Press ▲/▼/◀/▶ to select the picture, and then press [MENU/SET] to set. (Repeat this step.)**

- [RECALL] appears on the selected pictures.
If [MENU/SET] is pressed again, the setting is canceled.

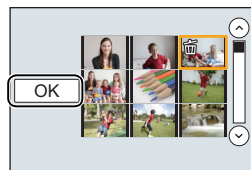

- 4 (When [Delete Multi] is selected)
Press ◀ to select [OK], and then press [MENU/SET] to execute.**

- Confirmation screen is displayed.
Pictures are deleted by selecting [Yes].

Recording

Taking Pictures using the Automatic Function (Intelligent Auto Mode)

Recording Mode:  

In this mode, the camera makes the optimal settings for the subject and scene, so we recommend it when you wish to leave the settings to the camera and record without thinking about them.

1 Set the mode dial to .

- The camera will switch to either the most recently used of Intelligent Auto Mode or Intelligent Auto Plus Mode. At the time of purchase, the mode is set to Intelligent Auto Plus Mode. (P24)

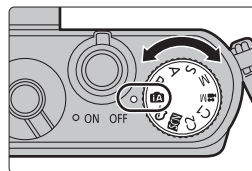





2 Align the screen with the subject.

- When the camera identifies the optimum scene, the icon of the scene concerned is displayed in blue for 2 seconds, after which its color changes to the usual red. (Automatic scene detection)
- When the subject is touched, AF Tracking function works. It is also possible by pressing the cursor button towards , and then pressing the shutter button halfway.



■ Switching between Intelligent Auto Plus Mode and Intelligent Auto Mode

- 1 Press **[MENU/SET]**.
- 2 Press **◀**.
- 3 Press **▲/▼** to select the  or  tab.
- 4 Press **◀/▶** to select  or  and then press **[MENU/SET]**.
 - If **[DISP.]** is pressed, the description of the selected mode will be displayed.



■ Recording night scenes ([iHandheld Night Shot])

When **[iHandheld Night Shot]** is set to **[ON]** and  is detected while taking handheld night shots, pictures of the night scenery will be taken at a high burst speed and composed into a single picture.

[MENU] →  **[Rec]** → **[iHandheld Night Shot]** → **[ON]/[OFF]**

Recording

■ Combining pictures into a single picture with rich gradation ([iHDR])

When [iHDR] is set to [ON] and there is, for example, strong contrast between the background and the subject, multiple still pictures are recorded with differing exposures and combined to create a single still picture rich in gradation.

[iHDR] works automatically as needed. When it does, [HDR] is displayed on the screen.

MENU →  **[Rec]** → **[iHDR]** → **[ON]/[OFF]**

■ Taking a picture with a blurred background (Defocus Control)

You can easily set the blurriness of the background while checking the screen.

1 Press **▲** to display the setting screen.

- Each time **▲** is pressed in Intelligent Auto Plus Mode, the camera switches between brightness setting operation, Defocus Control operation, and normal operation.
- Each time **▲** is pressed in Intelligent Auto Mode, the camera switches between Defocus Control operation and normal operation.

2 Rotate the control dial to set the blurriness.

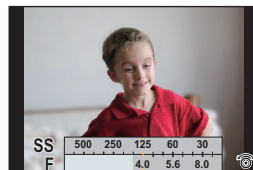

■ Recording images by changing the brightness or color tone

Recording Mode: 

This mode enables you to change the brightness and color tone to your preferred settings from the ones set by the camera.

■ Setting brightness

1 Press **▲** to display the setting screen.

- Each press of **▲** switches among brightness setting, Defocus Control and end operation.

2 Rotate the control dial to adjust brightness.



■ Setting color

1 Press **▶** to display the setting screen.

2 Rotate the control dial to adjust color.

- This will adjust the color of the image from a reddish color to a bluish color.
- Press [MENU/SET] to return to the recording screen.

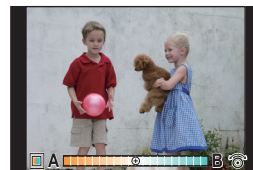

Recording

Taking Pictures with Manual Focus

Applicable modes:

Use this function when you want to fix the focus or when the distance between the lens and the subject is determined and you do not want to activate Auto Focus.

The operations to focus manually differ depending on the lens used.

When using an interchangeable lens (H-FS12032) with no focus ring

- 1 Set the focus mode lever to [MF].
- 2 Press ◀ ().

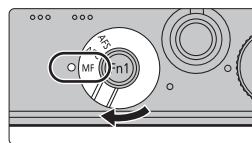

- 3 Press ▲/▼/◀/▶ to move the MF area, and press [MENU/SET].

- The MF area can also be moved by dragging the screen (P13).
- Pressing [DISP.] will return the MF area back to the center.

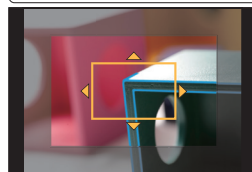

- 4 Press ◀/▶ to focus.

- (A) Slide bar
- (B) MF Assist (enlarged screen)
- (C) MF Guide
- (D) Peaking

- Pressing and holding ◀/▶ will increase the focus speed.
- Focus can also be adjusted by dragging the slide bar.
- Rotating the control dial will enlarge/reduce the MF Assist size.
- When [Peaking] in the [Custom] menu is set to [ON], in-focus portions are highlighted.
- The MF area setting screen can be displayed by pressing ▼.

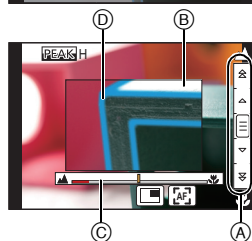

■ Displaying the MF Assist

- It can be displayed by rotating the focus ring, pinching out (P13) the screen, or touching the screen twice. (In [Miniature Effect] of Creative Control Mode, it cannot be displayed by touching the screen)
- It can also be displayed by pressing ◀ of the cursor button to display the MF area setup screen, using the cursor button to decide the MF area position, and then pressing [MENU/SET].

■ Closing the MF Assist

- It will close when the shutter button is pressed halfway.
- You can also close MF Assist by pressing [MENU/SET] or touching [Exit].
- It will also close when the screen is touched twice.
- When displayed by rotating the focus ring, it is closed approximately 10 seconds after operations are stopped.

Wi-Fi

Controlling with a Smartphone/Tablet

Using a smartphone/tablet, you can record images on the camera and save them.

You need to install "Panasonic Image App" (referred to as "Image App" from this point on) on your smartphone/tablet.



■ About the [Wi-Fi] button

At the time of purchase, [Wi-Fi] is set to [Fn1].
In the chapter for "Wi-Fi", [Fn1] is written as [Wi-Fi].

- Refer to P19 for details about the function button.

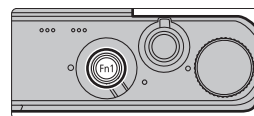

Installing the smartphone/tablet app "Image App"

The "Image App" is an application provided by Panasonic.

• OS

For Android™ apps: Android 2.2 to Android 4.3*

For iOS apps: iOS 5.0 to iOS 7.0

- * Connecting to this unit with [Wi-Fi Direct] requires Android OS 4.0 or higher and Wi-Fi Direct™ support.

- 1 Connect the smartphone/tablet to a network.**
- 2 (Android) Select "Google Play™ Store".**
(iOS) Select "App StoreSM".
- 3 Enter "Panasonic Image App" into the search box.**
- 4 Select "Panasonic Image App"  and install it.**

- Use the latest version.
- The service may not be able to be used properly depending on the type of smartphone/tablet being used.

For information on the "Image App", refer to the support site below.

<http://panasonic.jp/support/global/cs/dsc/>

(This Site is English only.)

- When downloading the app on a mobile network, high packet communication fees may be incurred depending on the details of your contract.

Wi-Fi

Connecting to a smartphone/tablet

By pressing and holding [Wi-Fi], you can easily establish a connection.

Preparations:

- Install the “Image App” in advance. (P27)

1 Press and hold [Wi-Fi].

- The information (SSID and password) required for directly connecting your smartphone/tablet to this unit is displayed.
- Except for when connecting for the first time, the screen from the previous connection is displayed.

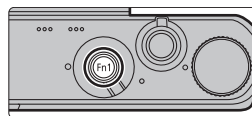

2 Operate the smartphone/tablet.

- 1 Turn on the Wi-Fi function.
- 2 Select the SSID that matches the one displayed on the screen of this unit, and then enter the password.
- 3 Start “Image App”. (P27)
 - When the connection is complete, live images being captured by the camera are displayed on the smartphone/tablet.

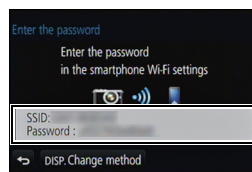

Taking pictures via a smartphone/tablet (remote recording)

1 Connect to a smartphone/tablet.

2 Select [Image] on the smartphone/tablet.

- The recorded images are saved in the camera.
- Some settings are not available.
- The screen differs depending on the OS.
- When a high ambient temperature, continuous motion picture recording or other conditions are causing the camera to overheat, [Heat] flashes. If a message is displayed after [Heat] flashes, the camera will turn off automatically to protect itself. When this happens, some functions will be disabled until the camera cools down.



Saving images stored in the camera/Sending images in the camera to an SNS

1 Connect to a smartphone/tablet.

2 Select [Image] on a smartphone/tablet.

3 Drag an image.

- If an image is touched, the picture will be played back in an enlarged size.
- The function can be assigned to the top, bottom, left or right according to your preference.

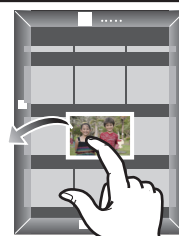

About the supplied software

The supplied CD-ROM includes the following software.
Install the software on to your computer before use.

- **PHOTOfunSTUDIO 9.2 AE (Windows XP/Vista/7/8)**
- **SILKYPIX Developer Studio**
(Windows XP/Vista/7/8, Mac OS X v10.5/v10.6/v10.7/v10.8)

For details on how to use the SILKYPIX Developer Studio, refer to the “Help” or the Ichikawa Soft Laboratory’s support website:
<http://www.isl.co.jp/SILKYPIX/english/p/support/>

- **LoiLoScope 30 day full trial version (Windows XP/Vista/7/8)**
– This will only install a shortcut to the trial version download site.

For more information on how to use LoiLoScope, read the LoiLoScope manual available for download at the link below.
Manual URL: <http://loilo.tv/product/20>

■ Installing supplied software

- Before inserting the CD-ROM, close all running applications.

1 Check the environment of your PC.

- For details about information such as the operating environment or operating method, refer to the “Owner’s Manual for advanced features (PDF format)” or the operating instructions for the respective software programs.

2 Insert the CD-ROM with the supplied software.

3 Click on the [Recommended Installation] on the install menu to install.

- If the automatic playback screen is displayed, you can display the menu by selecting and executing [InstMenu.exe].
- In Windows 8, you can display the menu by clicking a message that is displayed after inserting the CD-ROM and then selecting and executing [InstMenu.exe].
- You can also display the menu by double-clicking [VFFXXXX] in [Computer] (XXXX differs depending on the model).
- Proceed with installation according to messages appearing on the screen.

- The software compatible with your PC will be installed.
- On the Mac, SILKYPIX can be installed manually.
 - 1 Insert the CD-ROM with the supplied software.
 - 2 Double-click on the automatically displayed folder.
 - 3 Double-click the icon in the application folder.

Not available in these cases:

- “PHOTOfunSTUDIO” and “LoiLoScope” are not compatible with Mac.

Others

Monitor Display

In recording

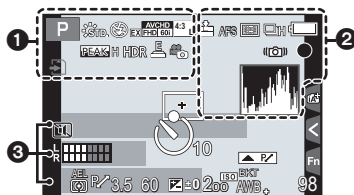

1		Recording Mode
		Custom settings
		Photo Style
		Creative control adjustment display
		Flash Mode
		Flash
		Extended Tele Conversion (when recording motion pictures)
		Recording format/Recording quality
		Picture size/Aspect Ratio
		Extended Tele Conversion (when taking still pictures)
		Card (displayed only during recording)
		Elapsed recording time ⁺¹
		Simultaneous recording indicator
		Peaking

	HDR/iHDR
	Multi exposure
	Digital Zoom
	Electronic shutter
	Picture Mode (Still picture priorities)
	Overheat indicator

2		Quality
		Focus Mode
		AF Mode
		Face Recognition
		AF Lock
		Burst
		Auto Bracket
		Self-timer
		Battery indication
		Optical Image Stabilizer ⁺²
		Jitter alert
		Recording state (Flashes red)/Focus (Lights green)
		Focus (Under low illumination)
		Connected to Wi-Fi
		Histogram

3		Name ⁺³
		Number of days that have passed since the departure date ⁺⁴
		Age ⁺³
		Location ⁺⁴
		Current date and time/Travel destination setting ⁺⁴ :

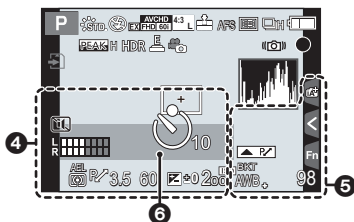

	AF area
	Spot metering target
	Self-timer ^{*5}
	Mic level display
	Silent Mode
	AEL AE Lock
	Metering Mode
	Program Shift
	3.5 Aperture value
	60 Shutter speed
	Exposure compensation value
	±0 Brightness
	Manual Exposure Assistance
	200 ISO sensitivity

	Dial operation guide
	White Balance Bracket
	White Balance Fine Adjustment
	White Balance
	Color
	98 Number of recordable pictures ^{*6}
	R8m30s Available recording time ^{*1,6}
	Touch tab
	Touch tab
	Touch tab
	Touch tab
	Touch tab

	Exposure meter
	Focal distance display
	Step zoom

*1 h: hour, m: minute, s: second.

*2 Only available when a lens that supports the Stabilizer function is attached.

*3 This is displayed for about 5 seconds when the camera is turned on if the [Profile Setup] setting is set.

*4 This is displayed for about 5 seconds when the camera is turned on, after setting the clock and after switching from Playback Mode to Recording Mode.

*5 This is displayed during countdown.

*6 It is possible to switch the display between the number of recordable pictures and available recording time with the [Remaining Disp.] setting in the [Custom] menu.

Others

In recording

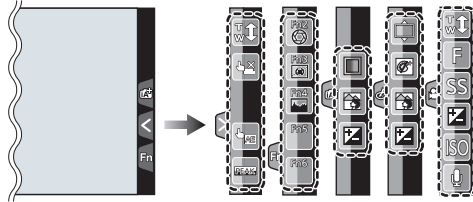

	Touch zoom		Brightness
	Touch Shutter		Type of defocus ([Miniature Effect])
	Touch AE		One point color
	Peaking		Position of the light source
	Fn2 (Function button)		Creative control adjustment
	Fn3 (Function button)		Aperture value
	Fn4 (Function button)		Shutter speed
	Fn5 (Function button)		ISO sensitivity
	Fn6 (Function button)		Microphone level adjustment
	Color		
	Defocus control function		

In playback

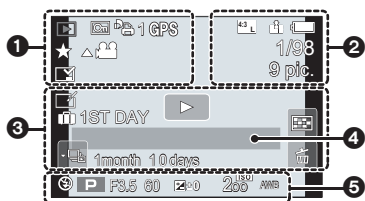

1

	Playback Mode
	Protected picture
	Number of prints
	Location Information display
	Favorites
	Cable disconnect prohibit icon
	Motion picture playback
	Continuous Burst Picture Group Playback
	Continuous [Time Lapse Shot] Picture Group Playback
	Continuous playback of the Stop Motion Animation Group
	Stamped with text indication
8m30s	Elapsed playback time*1

2

	Picture size/Aspect Ratio
	Recording format/Recording quality
	Quality
	Battery indication
1/98	Picture number/Total pictures
	Connected to Wi-Fi
9 pic.	Number of pictures in burst
8m30s	Motion picture recording time*1

3

	Clear Retouch completed icon
	Currently retrieving information icon
	Playback (Motion Pictures)
	Number of days that have passed since the departure date
	Burst Picture Group Display
	[Time Lapse Shot] Picture Group Display
	Display for the Stop Motion Animation Group
	Silent Mode
1 month 10days	Age
	Multi Playback
	Delete

4

Name*2
Location*2
Title*2

5

Recording information*3

*1 h: hour, m: minute, s: second.

*2 It is displayed in order of [Title], [Location], [Name] ([Baby1]/[Baby2], [Pet]), [Name] ([Face Recog.]).

*3 This is not displayed for motion pictures recorded in [AVCHD].

Others

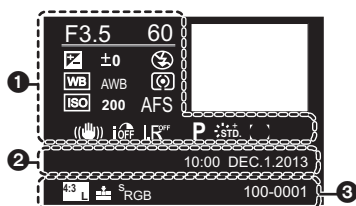
In playback**Detailed information display****1**

Recording information

iOFF	Intelligent Dynamic Range Control* ¹
HDR	HDR* ² /iHDR* ²
I.R. ^{OFF}	Intelligent Resolution
{ }	Shading Compensation* ²

2

Recorded date and time/World Time

3

4:3	Picture size/Aspect Ratio
RAW	Quality
S_RGB	Color space* ²
100-0001	Folder/File number* ¹

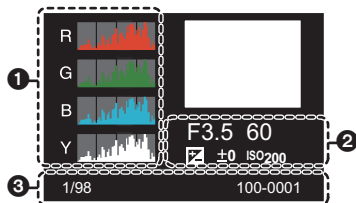
Histogram display**1**

Histogram

2Recording information*¹**3**

1/98	Picture number/Total pictures
100-0001	Folder/File number* ¹

*¹ This is not displayed for motion pictures recorded in [AVCHD].*² This is not displayed for motion pictures.

Others

Menu list

[Rec]

- If any of the settings common to both the [Rec] and [Motion Picture] menus have been changed, the corresponding setting in the other menu will also be changed.

[Photo Style]	You can select effects to match the type of image you wish to record. You can adjust the color and image quality of the effects.
[Aspect Ratio]	Sets the aspect ratio of the image.
[Picture Size]	Set the number of pixels.
[Quality]	Set the compression rate at which the pictures are to be stored.
[Sensitivity]	This allows the sensitivity to light (ISO sensitivity) to be set.
[Metering Mode]	Sets the light metering method for measuring brightness.
[Burst Rate]	Sets the burst speed for burst recording.
[Auto Bracket]	Sets single/burst recording, compensation range and recording sequence for Auto Bracket recording.
[Self Timer]	Sets the manner in which the self-timer works.
[i.Dynamic] (Intelligent dynamic range control)	Adjusts the contrast and exposure.
[i.Resolution]	Records pictures with more defined outlines and sense of clarity.
[i.Handheld Night Shot]	Pictures of the night scenery will be taken at a high burst speed and composd into a single picture.
[iHDR]	There is, for example, strong contrast between the background and the subject, multiple still pictures are recorded with differing exposures and combined to create a single still picture rich in gradation.
[HDR]	You can combine 3 pictures with different levels of exposure into a single picture with rich gradation.
[Multi Exp.]	Gives an effect like multi exposure. (up to 4 times equivalent per a single image)
[Time Lapse Shot]	You can set the recording start time, the recording interval and the number of pictures, and automatically record subjects such as animals and plants as time elapses.
[Stop Motion Animation]	A stop motion picture is created by splicing pictures together.
[Shutter Type]	This enables you to choose whether pictures will be taken with the Electronic Front Curtain or the electronic shutter.
[Flash]	Sets the manner in which the flash works.
[Red-Eye Removal]	Automatically detects red-eye caused by the flash and corrects the image data accordingly.

Others

[ISO Limit Set]	When the ISO sensitivity is set to [AUTO] or [ISO], an optimal ISO sensitivity is set with the selected value as an upper limit.
[ISO Increments]	The ISO sensitivity settings values changes in steps of 1/3 EV or 1 EV.
[Extended ISO]	ISO sensitivity can be set up to minimum [ISO125].
[Long Shtr NR]	You can eliminate the noise caused by recording with a slower shutter speed.
[Shading Comp.]	If the screen periphery darkens as a result of lens characteristics, the brightness in this region will be corrected.
[Ex. Tele Conv.]	When the number of pixels is set to anything other than [L], the Tele effect is increased without degradation in image quality.
[Digital Zoom]	Increases the Tele effect. The higher the level of magnification, the greater the degradation in image quality.
[Color Space]	Set this when you want to correct the color reproduction of the recorded pictures on a PC, printer etc.
[Stabilizer]	When camera shake is sensed during recording, the camera corrects it automatically.
[Face Recog.]	Sets the focus and exposure automatically prioritizing registered faces.
[Profile Setup]	If you set the name and birthday of your baby or pet in advance, you can record their name and age in months and years in the images.

[Motion Picture]

- [Photo Style], [Sensitivity], [Metering Mode], [i.Dynamic], [i.Resolution] and [Digital Zoom] are common to both the [Rec] menu and [Motion Picture] menu. Changing these settings in one of these menus is reflected in other menu.



For details, refer to the explanation for the corresponding setting in the [Rec] menu.

[Rec Format]	Sets the file format for the motion pictures you record.
[Rec Quality]	This sets up the picture quality of motion pictures.
[Exposure Mode]	Select the method for setting the aperture value and shutter speed in Creative Video Mode.
[Picture Mode]	Sets the recording method for still pictures during motion picture recording.
[Continuous AF]	Continues to focus on the subject for which focus has been achieved.
[Rec Highlight]	White saturated areas appear blinking in black and white.
[Ex. Tele Conv.]	Increases the Tele effect.
[Flkr Decrease]	The shutter speed can be fixed to reduce the flicker or striping in the motion picture.
[Silent Operation]	Enables touch operations to allow silent use while recording motion pictures.
[Mic Level Disp.]	Set whether or not the mic levels are displayed on the screen.
[Mic Level Adj.]	Adjust the sound input level to 4 different levels.
[Wind Cut]	Reduces the wind noise effectively if there is wind noise when recording sound.

[Custom]

[Cust.Set Mem.]	Registers the current camera settings as custom set.
[Silent Mode]	Disables operational sounds and output of light at once.
[AF/AE Lock]	Sets the fixed content for focusing and exposure when the AF/AE lock is on.
[Half Press Release]	The shutter will immediately fire when the shutter button is pressed halfway.
[AFS/AFF]	Assigns [AFS] or [AFF] to [AFS] of the focus mode lever.
[Quick AF]	Speeds up the focusing that takes place when you press the shutter button.
[Pinpoint AF Time]	Sets the time for which the screen is enlarged when the shutter button is pressed halfway with Auto Focus Mode set to [+].
[Pinpoint AF Display]	Sets whether to display the assist screen that appears when Auto Focus Mode is set to [+].
[AF Assist Lamp]	AF assist lamp will illuminate the subject when the shutter button is pressed half-way making it easier for the camera to focus when recording in low light conditions.
[Focus/Release Priority]	It will set so no picture can be taken when it is out of focus.
[AF+MF]	You can set the focus manually after the automatic focus has finished.
[MF Assist]	Sets the display method of MF Assist (enlarged screen).
[MF Assist Display]	Sets whether MF Assist (enlarged screen) will appear in a windowed screen display or in a full screen display.
[MF Guide]	When you set the focus manually, an MF guide that allows you to check the direction to achieve focus is displayed.
[Peaking]	In-focus portions are highlighted when focus is being adjusted manually.
[Histogram]	This allows you to set either to display or not display the histogram.
[Guide Line]	This will set the pattern of guide lines displayed when taking a picture.
[Highlight]	When the Auto Review function is activated or when playing back, white saturated areas appear blinking in black and white.
[Constant Preview]	You can check the effects of the chosen aperture and shutter speed on the recording screen in Manual Exposure Mode.
[Expo.Meter]	Set whether or not to display the exposure meter.
[Dial Guide]	Set whether or not to display the dial operation guide.
[Rec Area]	This changes the angle of view during motion picture recording and still picture recording.
[Remaining Disp.]	This will switch display between the number of recordable pictures and available recording time.
[Auto Review]	Displays a picture immediately after it is taken.
[Fn Button Set]	You can assign various recording and other functions to the function button.

Others

[Q.MENU]	Switch the setting method of Quick Menu.
[Video Button]	Enables/disables the motion picture button.
[Power Zoom Lens]	Sets the screen display and lens operations when using an interchangeable lens that is compatible with power zoom (electrically operated zoom).
[Lens w/o Focus Ring]	Sets the control dial operation for MF Assist.
[Touch Settings]	Enables/disables the Touch operation.
[Touch Scroll]	This allows you to set the speed of continuously forwarding or rewinding pictures using touch operation.
[Menu Guide]	Set the screen that is displayed when the mode dial is set to  and  .
[Shoot w/o Lens]	Sets whether or not the shutter can be released when no lens is attached to the main body.

[Setup]

[Clock Set]	Setting Date/Time.
[World Time]	Sets the times for the region where you live and your holiday destination.
[Travel Date]	Departure date and return date of the trip as well as the name of the travel destination can be set.
[Wi-Fi]	Configure the each setting for Wi-Fi functions.
[Beep]	This allows you to set the volume for electronic sound and the electronic shuttersound.
[Speaker Volume]	Adjust the volume of the speaker to any of 7 levels.
[Monitor Display]	Brightness, color, or red or blue tint of the Monitor is adjusted.
[Monitor Luminance]	Set the monitor brightness to suit the amount of surrounding light.
[Economy]	Suppresses the unit's power consumption to prevent the battery from being run down.
[USB Mode]	Sets the communication method when connecting using the USB connection cable (supplied).
[Output]	This sets how the unit connects to a television etc.
[VIERA Link]	Equipment that supports the VIERA Link will connect automatically.
[3D Playback]	Set the output method for 3D pictures.
[Menu Resume]	Stores the location of the last-used menu item for each menu.
[Menu Background]	Set the background color for the menu screen.
[Menu Information]	Descriptions of menu items or their settings are displayed on the menu screen.
[Language]	Set the language displayed on the screen.
[Version Disp.]	This enables the firmware versions of the camera and lens to be checked.
[Exposure Comp. Reset]	An exposure value can be reset when the Recording Mode is changed or the camera is turned off.

Others

[Self Timer Auto Off]	Sets whether or not to cancel the self-timer when this unit is turned off.
[No.Reset]	Returns the image file number to 0001.
[Reset]	The recording or setup/custom settings are reset to the default.
[Reset Wi-Fi Settings]	Reset all settings in the [Wi-Fi] menu to factory default settings. (Excluding [LUMIX CLUB])
[Pixel Refresh]	It will perform optimization of imaging device and image processing.
[Sensor Cleaning]	Dust reduction to blow off the debris and dust that have affixed to the front of the imaging device is performed.
[Format]	The card is formatted.

[Playback]

[2D/3D Settings]	Switches the playback method for 3D images.
[Slide Show]	Selects the type etc. of the images and plays back in order.
[Playback Mode]	Selects the type etc. of the images and plays back only particular images.
[Location Logging]	The location information (longitude/latitude) acquired by the smartphone/tablet can be sent to the camera and written in images.
[Clear Retouch]	You can erase unnecessary parts recorded on the pictures taken.
[Title Edit]	Input texts (comments) on the recorded pictures.
[Text Stamp]	Stamps the recorded pictures with recording date and time, names, travel destination, travel date, etc.
[Video Divide]	Splits the recorded motion picture in two.
[Time Lapse Video]	Creates a motion picture from a set of group pictures recorded with the [Time Lapse Shot].
[Stop Motion Video]	Creates a motion picture from the Stop Motion Animation group.
[Resize]	Reduces the image size (number of pixels).
[Cropping]	Crops the recorded image.
[Rotate]	Rotate pictures manually in 90° steps.
[Rotate Disp.]	This mode allows you to display pictures vertically if they were recorded holding the camera vertically.
[Favorite]	Marks can be added to images, and images can be set as favorites.
[Print Set]	Sets the images for printing and the number of prints.
[Protect]	Protects images to prevent deletion by mistake.
[Face Rec Edit]	Removes or changes information relating to personal identity.
[Delete Confirmation]	This sets which option, [Yes] or [No], will be highlighted first when the confirmation screen for deleting a picture is displayed.

Others

Troubleshooting

First, try out the following procedures.

If the problem is not resolved, it may be improved by selecting [Reset] on the [Setup] menu.

**The camera cannot be operated even when it is turned on.
The camera turns off immediately after it is turned on.**

- The battery is exhausted.
→ Charge the battery.
- If you leave the camera on, the battery will be exhausted.
→ Turn the camera off frequently by using the [Economy] etc.

This unit suddenly turns off during recording.

- When a high ambient temperature, continuous recording in Burst Mode or of a motion picture, continuous use of a Wi-Fi connection or other conditions are causing the camera to overheat, [△] flashes. If a message is displayed after [△] flashes, the camera will turn off automatically to protect itself. When this happens, some functions will be disabled until the camera cools down.

The subject is not focused properly.

- The subject is beyond the focus range of the camera.
- There is camera shake (jitter) or the subject is moving slightly.
- Is [Focus/Release Priority] in the [Custom] menu set to [RELEASE]?
- Is the AF Lock applied incorrectly?

**The recorded picture is blurred.
The Optical Image Stabilizer is not effective.**

- The shutter speed will become slower and the Optical Image Stabilizer function may not work properly when taking pictures especially in dark places.
→ We recommend holding the camera firmly with both hands when taking pictures.
→ We recommend using a tripod and the self-timer when taking pictures with a slow shutter speed.
- Are you using a lens which supports the Stabilizer function?
- When a moving subject is recorded with the electronic shutter, the subject may appear distorted on the picture.

Striping or flicker may appear under lighting such as fluorescent lighting and LED lighting fixture.

- This is characteristic of MOS sensors which serve as the camera's pickup sensors.
This is not a malfunction.
- Are you taking pictures with the electronic shutter?
→ When using the electronic shutter, lowering the shutter speed may reduce the effect of the horizontal stripes.

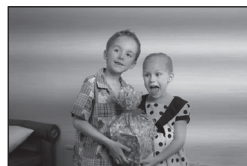

Others

The brightness or the hue of the recorded picture is different from the actual scene.

- When recording under fluorescent or LED lighting fixture, etc., increasing the shutter speed may introduce slight changes to brightness and color. These are a result of the characteristics of the light source and do not indicate a malfunction.
- When recording subjects in extremely bright locations or recording under fluorescent lighting, LED lighting fixture, mercury lamp, sodium lighting, etc., the colors and screen brightness may change or horizontal striping may appear on the screen.

Recording motion pictures is not possible.

- You may not be able to record for a short while after turning this unit on when using a large capacity card.

The screen may be blacked out momentarily, or the unit may record noise.

- The screen may be blacked out momentarily, or the unit may record noise due to static electricity or electromagnetic waves etc. depending on the environment of the motion picture recording.

The flash is not activated.

- Is the flash closed?
→ Open the flash.
- When the electronic shutter is used, the flash is not activated.
→ Set [Shutter Type] to [AUTO] or [EFC].
- When [Silent Mode] is set to [ON], the flash is not activated.
→ Set [Silent Mode] to [OFF].

**The picture is not played back.
There are no recorded pictures.**

- Is the card inserted?
- Is there a picture on the card?
- Is this a folder or picture which was processed in the PC?
If it is, it cannot be played back by this unit.
→ It is recommended to use the "PHOTOfunSTUDIO" software in the CD-ROM (supplied) to write pictures from PC to card.
- Has [Playback Mode] been set for playback?
→ Change to [Normal Play].

The folder number and the file number are displayed as [—] and the screen turns black.

- Is this a non-standard picture, a picture which has been edited using a PC or a picture which was taken by another make of digital camera?
- Did you remove the battery immediately after picture-taking or did you take the picture using a battery with a low remaining charge?
→ To delete such pictures, make a backup of the data and format the card.

Others

[Thumbnail is displayed] appears on the screen.

- Is it a picture that has been recorded with other equipment?
In such cases, these pictures may be displayed with a deteriorated picture quality.

Motion pictures recorded with this model cannot be played back on other equipment.

- Motion pictures recorded in [AVCHD] or [MP4] may be played back with poor picture or sound quality or playback may not be possible even when played back with equipment compatible with these formats. Also, the recording information may not be displayed properly.

**A Wi-Fi connection cannot be established.
Radio waves get disconnected.
Wireless access point is not displayed.**

■ **General tips for using a Wi-Fi connection**

- Use within the communication range of the device to be connected.
- Is any device, such as microwave oven, cordless phone, etc., that uses 2.4 GHz frequency operated nearby?
→ Radio waves may get interrupted when used simultaneously. Use them sufficiently away from the device.
- When the battery indicator is flashing red, the connection with other equipment may not start or the connection may be disrupted.
(A message such as [Communication error] is displayed.)

■ **About a wireless access point**

- Check if the wireless access point to connect is in operating state.
- The camera may not display or connect to a wireless access point depending on the radio wave condition.
→ Move this unit closer to the wireless access point.
→ Remove the obstacles between this unit and the wireless access point.
→ Change the direction of this unit.
→ Change the location and orientation of the wireless access point.
→ Perform the [Manual Connection].
- It may not display even if the radio waves exist depending on the setting of the wireless access point.
→ Check the settings of the wireless access point.
→ When the network SSID of the wireless access point is set not to broadcast, the wireless access point may not be detected. Enter the network SSID to start the connection or enable the SSID broadcast of the wireless access point.
- Connection types and security setting methods are different depending on the wireless access point. (Refer to the operating instructions of the wireless access point.)
- Is the 5 GHz/2.4 GHz switchable wireless access point connected to other equipment using the 5 GHz band?
→ The use of a wireless access point that can use 5 GHz/2.4 GHz simultaneously is recommended. It cannot be used simultaneously with this camera if it is not compatible.

Images cannot be transmitted to a PC.

- When the firewall of the OS, security software, etc. is enabled, connecting to the PC may not be possible.

42 VQT5D49 (ENG)

Others

Transmission of the image fails midway. Some images cannot be transmitted.

- Image cannot be transmitted when the battery indicator is flashing red.
- Is the size of the image too large?
 - Reduce the image size at [Size], and then send.
 - Transmit after dividing the motion picture with [Video Divide].
- File format of the motion picture that can be sent differs depending on the destination.
- Capacity or number of images in the web service is full.
 - Login to "LUMIX CLUB", and check the status of the destination on the web service link settings.

The motion pictures cannot be played back on a TV.

- Are you trying to play back the motion pictures by directly inserting the card in the card slot of the TV?
 - Connect the camera to the TV with the AV cable (optional), or with the HDMI micro cable, and then play back the motion pictures on the camera.

VIERA Link does not work.

- Is it connected properly with the HDMI micro cable?
- Is the [VIERA Link] on this unit set to [ON]?
 - If the input channel does not switch automatically, use the remote control for the TV to switch it.
 - Check the VIERA Link setting on the connected device.
 - Turn this unit off and on.
 - Set [HDAVI Control] to [Off] on the TV and then turn it back to [On].
(Refer to the operating instructions of the TV for details.)

The shutter remains closed when the camera is turned off (including Sleep Mode).

- If the camera is shaken, it may cause the shutter to close. This is not a malfunction. Do not put your finger in the mount. Turning on the camera will re-open the shutter.

There is a sound from lens unit.

- It is a sound of lens movement or aperture operation when this unit is turned on or off, and it is not a malfunction.
- The sound, which is caused by the automatic adjustment of the aperture, is heard when the brightness has changed due to, for example, zooming or the movement of the camera. This is not a malfunction.

The camera becomes warm.

- The surface of the camera may become warm during use. This does not affect the performance or quality of the camera.

The clock is reset.

- If you do not use the camera for a long time, the clock may be reset.
 - [Please set the clock] message will be displayed; please reset the clock. (P17)

Others

Specifications

Specifications are subject to change without notice.

Digital Camera Body (DMC-GM1):

Information for your safety

Power Source:	DC 8.4 V
Power Consumption:	2.3 W (When recording) [When the Interchangeable lens (H-FS12032) is used] 1.5 W (When playing back) [When the Interchangeable lens (H-FS12032) is used]
Camera effective pixels	16,000,000 pixels
Image sensor	4/3" Live MOS sensor, total pixel number 16,840,000 pixels, Primary color filter
Digital Zoom	Max. 4×
Extended Tele Conversion	When taking still pictures: Max. 2× (When a picture size of [S] (4 M), aspect ratio of [4:3] is selected.) When recording motion pictures: 2.4×/3.6×/4.8×
Focus	Auto Focus/Manual Focus, Face Detection/AF Tracking/23-area-focusing/ 1-area-focusing/Pinpoint (Touch focus area selection possible)
Shutter type	Electronically-controlled, single curtain focal-plane shutter/ Electronic shutter

Others

Burst recording	
Burst speed	Mechanical shutter: 5 pictures/second (High speed), 4 pictures/second (Middle speed), 2 pictures/second (Low speed) Electronic shutter: 40 pictures/second (Super high speed), 10 pictures/second (High speed), 4 pictures/second (Middle speed), 2 pictures/second (Low speed)
Number of recordable pictures	Max. 7 pictures (when there are RAW files) Depends on the capacity of the card (when there are no RAW files)
ISO sensitivity (Standard Output Sensitivity)	AUTO/ $\frac{1}{2}$ ISO/125*/200/400/800/1600/3200/6400/12800/25600 (1/3 EV step change possible) *Only available when [Extended ISO] is set.
Minimum Illumination	Approx. 9 lx (when i-Low light is used, the shutter speed is 1/30th of a second) [When the Interchangeable lens (H-FS12032) is used]
Shutter speed	60 seconds to 1/500th of a second (Mechanical shutter) 1 seconds to 1/16000th of a second (Electronic shutter) Taking still pictures during motion picture recording: Motion picture priorities: 1/25th of a second to 1/16000th of a second Still picture priorities: 60 seconds to 1/16000th of a second
Metering range	EV 0 to EV 18
White Balance	Auto White Balance/Daylight/Cloudy/Shade/Incandescent lights/Flash/White set1/White set2/White Balance K set
Exposure (AE)	Program AE (P)/Aperture-priority AE (A)/Shutter-priority AE (S)/Manual exposure (M)/AUTO Exposure Compensation (1/3 EV Step, -5 EV to +5 EV)
Metering Mode	Multiple/Center weighted/Spot
Monitor	3.0" TFT LCD (3:2) (Approx. 1,040,000 dots) (field of view ratio about 100%) Touch screen

Others

Flash	Built-in pop up flash GN 5.6 equivalent (ISO200·m) [GN 4.0 equivalent (ISO100·m)] Flash range: Approx. 90 cm (3.0 feet) to 4.5 m (15.0 feet) [When the Interchangeable lens (H-FS12032) is mounted, WIDE, [ISO AUTO] is set] AUTO, AUTO/Red-Eye Reduction, Forced ON, Forced ON/ Red-Eye Reduction, Slow Sync., Slow Sync./Red-Eye Reduction, Forced OFF
Flash synchronization speed	Equal to or smaller than 1/50th of a second (Mechanical shutter)
Microphone	Stereo
Speaker	Monaural
Recording media	SD Memory Card/SDHC Memory Card*/SDXC Memory Card* (* UHS-I-compatible)
Picture size	
Still picture	When the aspect ratio setting is [4:3] 4592×3448 pixels, 3232×2424 pixels, 2272×1704 pixels When the aspect ratio setting is [3:2] 4592×3064 pixels, 3232×2160 pixels, 2272×1520 pixels When the aspect ratio setting is [16:9] 4592×2584 pixels, 3232×1824 pixels, 1920×1080 pixels When the aspect ratio setting is [1:1] 3424×3424 pixels, 2416×2416 pixels, 1712×1712 pixels

Others

Recording quality	
Motion pictures	[AVCHD] 1920×1080/60i (Sensor output is 60 frames/sec.) (17 Mbps)/ 1920×1080/60i (Sensor output is 30 frames/sec.) (24 Mbps)/ 1920×1080/24p (Sensor output is 24 frames/sec.) (24 Mbps)/ 1280×720/60p (Sensor output is 60 frames/sec.) (17 Mbps) [MP4] 1920×1080/30p (Sensor output is 30 frames/sec.) (20 Mbps)/ 1280×720/30p (Sensor output is 30 frames/sec.) (10 Mbps)/ 640×480/30p (Sensor output is 30 frames/sec.) (4 Mbps)
Quality	RAW/RAW+Fine/RAW+Standard/Fine/Standard/MPO+Fine/ MPO+Standard
Recording file format	
Still Picture	RAW/JPEG (based on "Design rule for Camera File system", based on "Exif 2.3" standard, DPOF corresponding)/MPO
Motion pictures	AVCHD/MP4
Audio compression	AVCHD Dolby® Digital (2 ch)
	MP4 AAC (2 ch)
Interface	
Digital	"USB 2.0" (High Speed)
Analog video/audio	NTSC Audio line output (monaural)
Terminal	
[AV OUT/DIGITAL]	Dedicated jack (8 pin)
[HDMI]	MicroHDMI TypeD

Others

Dimensions	Approx. 98.5 mm (W)×54.9 mm (H)×30.4 mm (D) [3.88" (W)×2.16"(H)×1.20" (D)] (excluding the projecting parts)
Mass (weight)	Approx. 204 g/0.45 lb [with the card and battery] Approx. 173 g/0.38 lb (camera body) Approx. 274 g/0.60 lb [with the Interchangeable lens (H-FS12032), card and battery]
Operating temperature	0 °C to 40 °C (32 °F to 104 °F)
Operating humidity	10%RH to 80%RH
Language select	[ENGLISH]/[ESPAÑOL]

Wireless transmitter

Compliance standard	IEEE 802.11b/g/n (standard wireless LAN protocol)
Frequency range used (central frequency)	2412 MHz to 2462 MHz (1 to 11ch)
Encryption method	Wi-Fi compliant WPA™/WPA2™
Access method	Infrastructure mode

Battery Charger (Panasonic DE-A99B):

Information for your safety

Input:	~ 110 V to 240 V, 50/60 Hz, 0.15 A
Output:	== 8.4 V, 0.43 A

Equipment mobility:

Movable

Battery Pack (lithium-ion) (Panasonic DMW-BLH7PP):

Information for your safety

Voltage/capacity:	7.2 V/680 mAh
--------------------------	---------------

Others

Interchangeable Lens	H-FS12032 "LUMIX G VARIO 12–32 mm/F3.5–5.6 ASPH./MEGA O.I.S."
Focal length	f=12 mm to 32 mm (35 mm film camera equivalent: 24 mm to 64 mm)
Aperture type	7 diaphragm blades/circular aperture diaphragm
Aperture range	F3.5 (Wide) to F5.6 (Tele)
Minimum aperture value	F22
Lens construction	8 elements in 7 groups (3 aspherical lenses, 1 ED lenses)
In focus distance	0.2 m (0.66 feet) to ∞ (from the focus distance reference line) (focal length 12 mm to 20 mm), 0.3 m (0.98 feet) to ∞ (from the focus distance reference line) (focal length 21 mm to 32 mm)
Maximum image magnification	0.13× (35 mm film camera equivalent: 0.26×)
Optical Image Stabilizer	Available
[O.I.S.] switch	None (Setting of the [Stabilizer] is done in [Rec] menu.)
Mount	"Micro Four Thirds Mount"
Angle of view	84° (Wide) to 37° (Tele)
Filter diameter	37 mm
Max. diameter	Approx. 55.5 mm (2.19 inch)
Overall length	Approx. 24 mm (0.94 inch) (from the tip of the lens to the base side of the lens mount when the lens barrel is recessed)
Mass (weight)	Approx. 70 g/0.15 lb

Others

Digital Camera Accessory System

Description	Accessory#
Battery Pack	DMW-BLH7
AC Adaptor ^{*1}	DMW-AC8
DC Coupler ^{*1}	DMW-DCC15
Body Cap	DMW-BDC1
Hand grip	DMW-HGR1
Tripod Adaptor ^{*2}	DMW-TA1
USB connection Cable	DMW-USBC1
AV Cable	DMW-AVC1
Mount Adaptor	DMW-MA1, DMW-MA2M, DMW-MA3R

*1 The AC Adaptor (optional) can only be used with the designated Panasonic DC Coupler (optional). The AC adaptor (optional) cannot be used by itself.

*2 Use if the attached lens is in contact with the tripod pedestal.

Product numbers correct as of October 2013. These may be subject to change.

- Some optional accessories may not be available in some countries.
- NOTE: Accessories and/or model numbers may vary between countries. Consult your local dealer.
- For lens-related optional accessories such as compatible lenses and filters, refer to catalogs/ Web pages, etc.

Others

Digital Camera Accessory Order Form

(For USA and Puerto Rico Customers)

Please photocopy this form when placing an order.

1. Digital Camera Model # _____

2. Items Ordered

Accessory #	Description	Price Each	Quantity	Total Price
Shipping & Handling				\$6.95
Subtotal				
Your State & Local Sales Tax				
Total				

3. Method of payment (check one)

- American Express
- VISA Credit Card # _____
- MasterCard Expiration Date _____
- Discover Customer Signature _____

(Please do not send cash)

4. Shipping information (UPS delivery requires complete street address)

Ship To:
 Mr. _____
 Mrs. _____
 Ms. _____
 First _____ Last _____ Phone#: _____
 Day () _____
 Street Address _____
 Night () _____
 City _____ State _____ Zip _____

TO OBTAIN ANY OF OUR DIGITAL CAMERA ACCESSORIES YOU CAN DO ANY OF THE FOLLOWING:

VISIT YOUR LOCAL PANASONIC DEALER

OR

CALL PANASONIC'S ACCESSORY ORDER LINE AT 1-800-332-5368
 [6 AM-6 PM M-F, PACIFIC TIME]

OR

MAIL THIS ORDER TO: PANASONIC NATIONAL PARTS CENTER
 20421 84th Ave S., Kent, WA 98032

Others

Limited Warranty (ONLY FOR U.S.A. AND PUERTO RICO)

Panasonic Products Limited Warranty

Limited Warranty Coverage (For USA and Puerto Rico Only)

If your product does not work properly because of a defect in materials or workmanship, Panasonic Corporation of North America (referred to as "the warrantor") will, for the length of the period indicated on the chart below, which starts with the date of original purchase ("warranty period"), at its option either (a) repair your product with new or refurbished parts, (b) replace it with a new or a refurbished equivalent value product, or (c) refund your purchase price. The decision to repair, replace or refund will be made by the warrantor.

Product or Part Name	Parts	Labor
Digital Camera	1 Year	1 Year
All included Accessories (Except Non-Rechargeable Batteries)	90 Days	Not Applicable
Only Non-Rechargeable Batteries	10 Days	Not Applicable

During the "Labor" warranty period there will be no charge for labor. During the "Parts" warranty period, there will be no charge for parts. This Limited Warranty excludes both parts and labor for non-rechargeable batteries, antennas, and cosmetic parts (cabinet). This warranty only applies to products purchased and serviced in the United States or Puerto Rico. This warranty is extended only to the original purchaser of a new product which was not sold "as is".

Mail-In Service--Online or Telephone Repair Request

Online Repair Request

To submit a new repair request and for quick repair status visit our Web Site at www.panasonic.com/repair.

Telephone Repair Request

You may contact us at: 1-800-211-PANA (7262)

When shipping the unit, carefully pack, include all supplied accessories listed in the Owner's Manual, and send it prepaid, adequately insured and packed well in a carton box. When shipping Lithium Ion batteries please visit our Web Site at www.panasonic.com/BatteryHandling as Panasonic is committed to providing the most up to date information. Include a letter detailing the complaint, a return address and provide a daytime phone number where you can be reached. A valid registered receipt is required under the Limited Warranty.

IF REPAIR IS NEEDED DURING THE WARRANTY PERIOD, THE PURCHASER WILL BE REQUIRED TO FURNISH A SALES RECEIPT/PROOF OF PURCHASE INDICATING DATE OF PURCHASE, AMOUNT PAID AND PLACE OF PURCHASE. CUSTOMER WILL BE CHARGED FOR THE REPAIR OF ANY UNIT RECEIVED WITHOUT SUCH PROOF OF PURCHASE.

Limited Warranty Limits And Exclusions

This warranty ONLY COVERS failures due to defects in materials or workmanship, and DOES NOT COVER normal wear and tear or cosmetic damage. The warranty ALSO DOES NOT COVER damages which occurred in shipment, or failures which are caused by products not supplied by the warrantor, or failures which result from accidents, misuse, abuse, neglect, mishandling, misapplication, alteration, faulty installation, set-up adjustments, misadjustment of consumer controls, improper maintenance, power line surge, lightning damage, modification, introduction of sand, humidity or liquids, commercial use such as hotel, office, restaurant, or other business or rental use of the product, or service by anyone other than a Factory Service Center or other Authorized Servicer, or damage that is attributable to acts of God.

Others

THERE ARE NO EXPRESS WARRANTIES EXCEPT AS LISTED UNDER "LIMITED WARRANTY COVERAGE".

THE WARRANTOR IS NOT LIABLE FOR INCIDENTAL OR CONSEQUENTIAL DAMAGES RESULTING FROM THE USE OF THIS PRODUCT, OR ARISING OUT OF ANY BREACH OF THIS WARRANTY.

(As examples, this excludes damages for lost time, travel to and from the servicer, loss of or damage to media or images, data or other memory or recorded content. The items listed are not exclusive, but for illustration only.)

ALL EXPRESS AND IMPLIED WARRANTIES, INCLUDING THE WARRANTY OF MERCHANTABILITY, ARE LIMITED TO THE PERIOD OF THE LIMITED WARRANTY.

Some states do not allow the exclusion or limitation of incidental or consequential damages, or limitations on how long an implied warranty lasts, so the exclusions may not apply to you. This warranty gives you specific legal rights and you may also have other rights which vary from state to state. If a problem with this product develops during or after the warranty period, you may contact your dealer or Service Center. If the problem is not handled to your satisfaction, then write to the warrantor's Consumer Affairs Department at the addresses listed for the warrantor.

PARTS AND SERVICE, WHICH ARE NOT COVERED BY THIS LIMITED WARRANTY, ARE YOUR RESPONSIBILITY.

Customer Services Directory (United States and Puerto Rico)

Obtain Product Information and Operating Assistance; locate your nearest Dealer or Service Center; purchase Parts and Accessories; or make Customer Service and Literature requests by visiting our Web Site at:

<http://www.panasonic.com/help>

or, contact us via the web at:

<http://www.panasonic.com/contactinfo>

You may also contact us directly at:

1-800-211-PANA (7262)

Monday-Friday 9am-9pm, Saturday-Sunday 10am-7pm EST

For hearing or speech impaired TTY users, TTY: 1-877-833-8855

Accessory Purchases (United States and Puerto Rico)

Purchase Parts, Accessories and Owner's Manual online for all Panasonic Products by visiting our Web Site at:

<http://www.pstc.panasonic.com>

Or, send your request by E-mail to:

npcparts@us.panasonic.com

You may also contact us directly at:

1-800-332-5368 (Phone) 1-800-237-9080 (Fax Only)

(Monday-Friday 9am-9pm EST)

Panasonic National Parts Center

20421 84th Ave S., Kent, WA 98032

(We accept Visa, MasterCard, Discover Card, American Express)

For hearing or speech impaired TTY users, TTY: 1-866-605-1277

As of July 2013

Others

This product incorporates the following software:

- (1) the software developed independently by or for Panasonic Corporation,
- (2) the software owned by third party and licensed to Panasonic Corporation, and/or
- (3) open source software

The software categorized as (3) is distributed in the hope that it will be useful, but WITHOUT ANY WARRANTY, without even the implied warranty of MERCHANTABILITY or FITNESS FOR A PARTICULAR PURPOSE.

Please refer to the detailed terms and conditions thereof displayed by selecting [MENU/SET] → [Setup] → [Version Disp.] → [Software info].

- G MICRO SYSTEM is a lens exchange type digital camera system of LUMIX based on a Micro Four Thirds System standard.
- Micro Four Thirds™ and Micro Four Thirds Logo marks are trademarks or registered trademarks of Olympus Imaging Corporation, in Japan, the United States, the European Union and other countries.
- Four Thirds™ and Four Thirds Logo marks are trademarks or registered trademarks of Olympus Imaging Corporation, in Japan, the United States, the European Union and other countries.
- SDXC Logo is a trademark of SD-3C, LLC.
- "AVCHD" and the "AVCHD" logo are trademarks of Panasonic Corporation and Sony Corporation.
- Manufactured under license from Dolby Laboratories. Dolby and the double-D symbol are trademarks of Dolby Laboratories.
- HDMI, the HDMI Logo, and High-Definition Multimedia Interface are trademarks or registered trademarks of HDMI Licensing LLC in the United States and other countries.
- HDAVI Control™ is a trademark of Panasonic Corporation.
- Adobe is a trademark or registered trademark of Adobe Systems Incorporated in the United States and/or other countries.
- Mac and Mac OS are trademarks of Apple Inc., registered in the U.S. and other countries.
- App Store is a service mark of Apple Inc.



- QuickTime and the QuickTime logo are trademarks or registered trademarks of Apple Inc., used under license therefrom.



- Windows and Windows Vista are either registered trademarks or trademarks of Microsoft Corporation in the United States and/or other countries.

- Android and Google Play are trademarks or registered trademarks of Google Inc.

- The Wi-Fi CERTIFIED Logo is a certification mark of the Wi-Fi Alliance.



- The Wi-Fi Protected Setup Mark is a mark of the Wi-Fi Alliance.



- "Wi-Fi", "Wi-Fi Protected Setup", "Wi-Fi Direct", "WPA" and "WPA2" are marks or registered marks of the Wi-Fi Alliance.

- DLNA, the DLNA Logo and DLNA CERTIFIED are trademarks, service marks, or certification marks of the Digital Living Network Alliance.



- This product uses "DynaFont" from DynaComware Corporation. DynaFont is a registered trademark of DynaComware Taiwan Inc.

- Other names of systems and products mentioned in these instructions are usually the registered trademarks or trademarks of the manufacturers who developed the system or product concerned.

This product is licensed under the AVC patent portfolio license for the personal and non-commercial use of a consumer to (i) encode video in compliance with the AVC Standard ("AVC Video") and/or (ii) decode AVC Video that was encoded by a consumer engaged in a personal and non-commercial activity and/or was obtained from a video provider licensed to provide AVC Video. No license is granted or shall be implied for any other use. Additional information may be obtained from MPEG LA, LLC. See <http://www.mpegla.com>.

Panasonic Corporation of North America
Two Riverfront Plaza, Newark, NJ 07102-5490

© Panasonic Corporation 2013

Printed in China